

devoLO

Home Control Radiator Thermostat



first steps

Thank you for placing your trust in this devolo product.

Carefully read all instructions before setting up the device and store the instructions for later reference.

Icons



Very important note. Failure to observe this note may result in damage.



Important note that should be observed.



Background information and configuration tips for your device.

Intended use

Use the Home Control Radiator Thermostat as described in these instructions and in the Home Control online help to prevent damage and injuries.



Except for insertion and occasional replacement of the batteries, the Home Control Radiator Thermostat is completely maintenance-free. Otherwise, the device contains no user-serviceable parts!

CE conformity



When used as intended, the product conforms to the basic requirements of the directives 2014/53/EU, 2014/35/EU and the other relevant provisions of the Radio and Telecommunications Terminal Equipment Act (FTEG) and is designed for use in the EU, Switzerland and Norway. A printout of the CE declaration is included.

devolo Home Control

Home Control (also known as home automation) refers to the specific control of electrically operated indoor household devices. The Home Control system by devolo uses the Z-Wave™ wireless standard.

A Home Control system requires a Z-Wave™-compatible control unit such as the Home Control Central Unit from devolo. Use its Home Control portal to coordinate the Home Control Radiator Thermostat and all other Home Control devices. You can access the Home Control Central Unit through the **my devolo app** and at **www.mydevolo.com** in a browser.

i *For more information about setting up the Home Control Central Unit, please refer to the installation guide and/or Home Control online help.*

Accessing the Home Control Central Unit via the my devolo app (for smartphone/tablet)

Open the **my devolo app** ⇨ **Home Control** and select your **Home Control Central Unit**.

Accessing the Home Control Central Unit via web browser (PC/laptop)

At **www.mydevolo.com** ⇨ **Home Control** select your **Home Control Central Unit**.

i *For more information on the control and configuration of all devolo Home Control devices, as well as application examples, please refer to the Home Control online help.*



The Home Control Radiator Thermostat

The radiator is controlled electronically, e.g. via the Home Control Central Unit (see section **devolo Home Control** on page 3 or manually via the function button and the navigation buttons on the thermostat. In the latter case, the Home Control Radiator Thermostat sends a change notification to the control unit, e.g. the Home Control Central Unit. In addition to the target temperature, the display shows the status of the respective battery, the wireless connection, an alarm and any keypad lock that may be in effect.

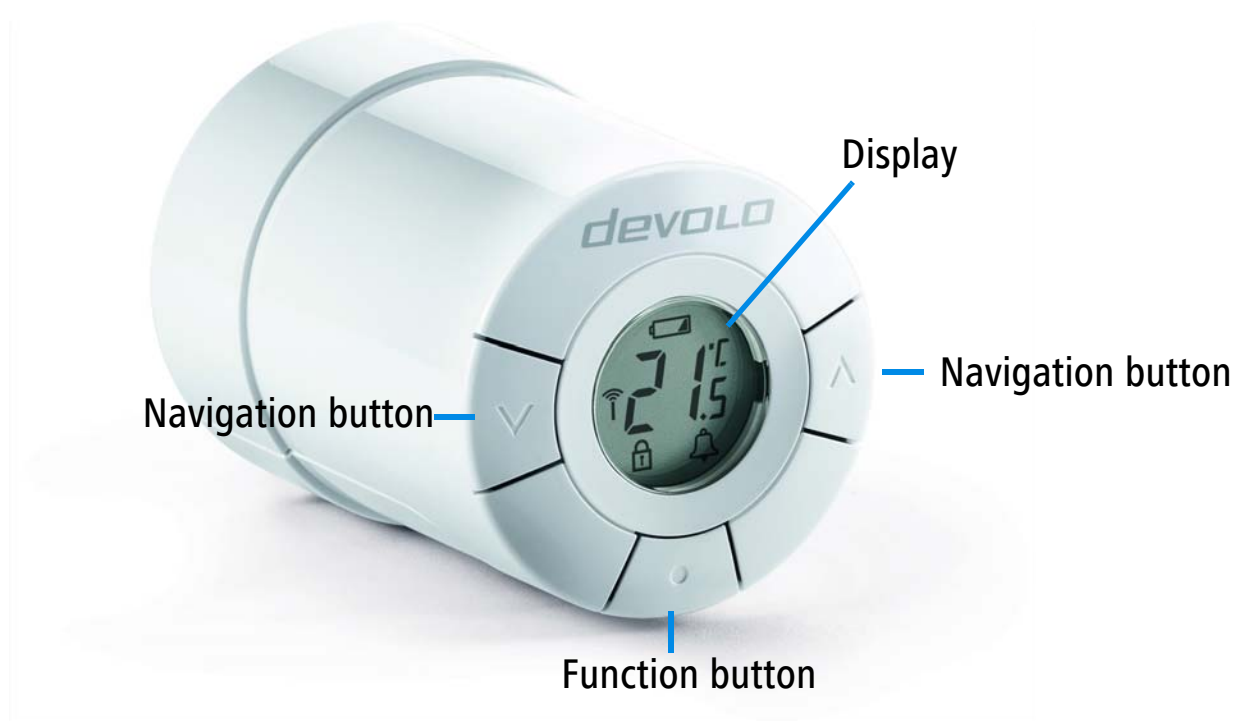

For more detailed descriptions of the Home Control Radiator Thermostat functions, refer to the Home Control online help.

Removing the existing thermostat

To ensure that the radiator valve is accessible for the installation of the Home Control Radiator Thermostat, remove the old thermostat or (for a new radiator) the protective cap.

- i** *Depending on the type, thermostats are removed differently; some are simply unscrewed, while others have to be detached using a standard tool. For more information, refer to the respective manufacturer's documentation.*

Inserting the batteries



Always keep batteries away from open flame and high temperatures. Avoid direct sunlight and heat radiation!

Always remove all batteries from battery-operated devices that are only in storage and are not in use. Old batteries can leak and damage the device!

Do not use rechargeable batteries!

When inserting the batteries, ensure that the polarity is correct. Using the batteries incorrectly can damage the device!

- i** *The Home Control Radiator Thermostat uses commercially available AA alkaline batteries. For information on replacing the battery, please refer to the Home Control online help.*

- ① Take off the battery compartment cover and insert the included batteries in the **correct position** (see marking in the battery compartment) into the Home Control Radiator Thermostat.

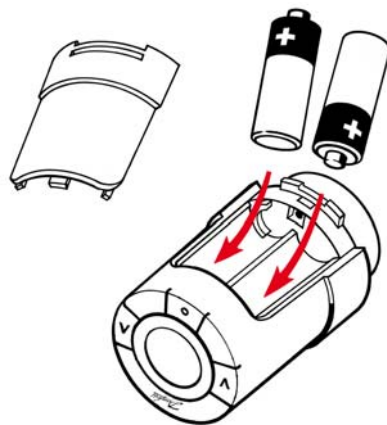

- ② After you have correctly inserted the batteries, the following symbol  flashes on the display of the Home Control Radiator Thermostat.
- ③ Reattach the battery compartment cover. You can now continue with the installation on the radiator.

Installing the Home Control Radiator Thermostat



Only use the Home Control Radiator Thermostat indoors.

The Home Control Radiator Thermostat is compatible with most commercially available radiator valves. For this purpose, two adapter rings are included with the Home Control Radiator Thermostat:

8

- The **narrow adapter ring** is compatible with the **M30 x 1.5 screw threads from** the following manufacturers: Comap/SAR, Heimeier, Honeywell-Braukmann, Idmar, Jaga, Junkers, MNG, Orkli, Oventrop, Pegler, R.B.M., Rossweiner, Schlösser, Siemens, Simplex, Tieme, Valv Sanayii, Watts.
 - The **wide adapter ring** is compatible with all **Danfoss RA valves**.
- ④ Plug or screw the correct adapter for your radiator onto the valve: Tighten the **wide adapter ring** using the included **Allen key**; tighten the **narrow adapter ring hand-tight**.

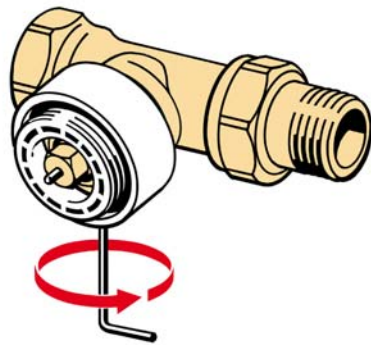

Wide

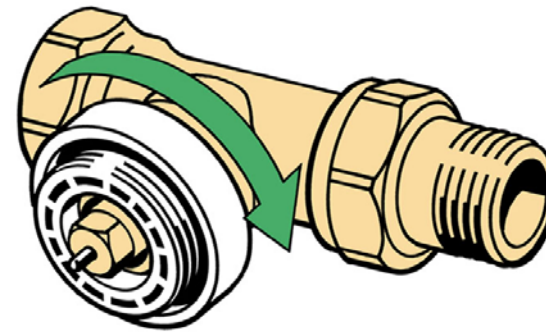



Narrow

- ⑤ Now, screw the Home Control Radiator Thermostat to the adapter ring installed on the radiator and tighten it hand-tight by rotating clockwise, applying gentle pressure.

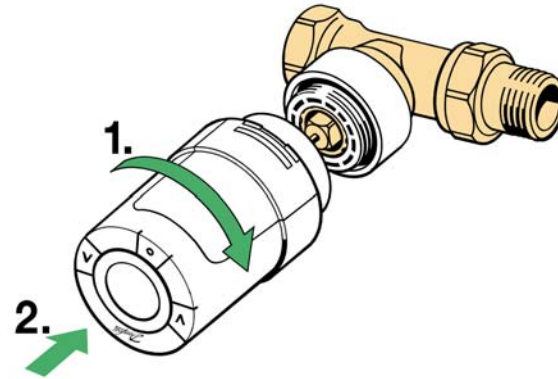
- ⑥ To fasten the Home Control Radiator Thermostat completely, press the centre **function button** for **3 seconds** . The device pulls tight on its own and is thus completely installed.



Registering the Home Control Radiator Thermostat on the control unit (e.g. Home Control Central Unit)

- ⑦ After you have successfully installed the Home Control Radiator Thermostat, continue with its electronic registration on the control unit.
- ⑧ When you use the **Home Control Central Unit** from **devolo**, follow the description in the section **devolo Home Control** on page 3 to call up your **Home Control Central Unit** and select **Devices**  **Add device**  **devolo Home Control Radiator Thermostat**. Follow the rest of the instructions there to log into your Home Control Central Unit. From now on, you can take electronic control conveniently using the Home Control portal of the Home Control Central Unit.
- i** *For more information on time control and configuration, as well as application examples, please refer to the Home Control online help.*

Service and warranty

Warranty: 3 years

If your devolo device is found to be defective during initial installation or within the warranty period, please contact the vendor who sold you the product. The vendor will take care of the repair or warranty claim for you. The complete warranty conditions can be found at www.devolo.com/warranty.

Great Britain	+44 203 0241 838 *	support@devolo.co.uk
Portugal	+351 707 200 896 *	support@devolo.pt
Spain	+34 902 887 682 *	support@devolo.es
Sweden	+46 771 400 480 *	support@devolo.se
Other countries	+49 241 70 525 18 *	support@devolo.com

* Detailed information about the actual costs of the telephone calls can be found on the devolo website.

Disposal

Neither the Home Control Radiator Thermostat nor the batteries may be disposed of with the household waste. Instead, you can return these at no charge at your municipal collection point or at the retailer (e. g. supermarket, specialist shop).



devolo

devolo AG

Charlottenburger Allee 60

52068 Aachen – Germany

www.devolo.com